



**EBARA**

CR8112EC

# **HOT WATER ABSORPTION CHILLER**

**(LOW TEMP. HOT WATER APPLICATION)**

Model **RCH**





For solar heat

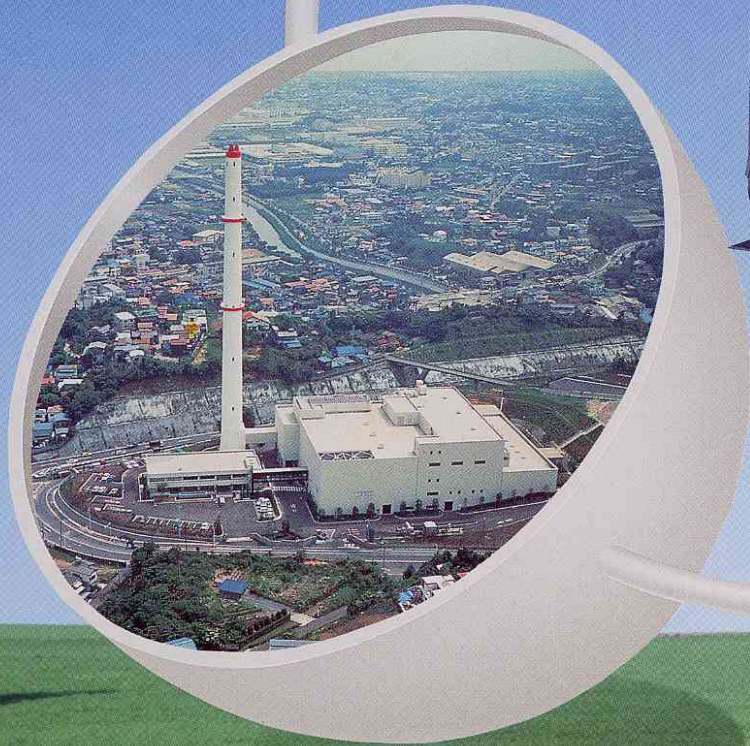

For exhaust heat from incineration plants

*Friendly to our earth.....*

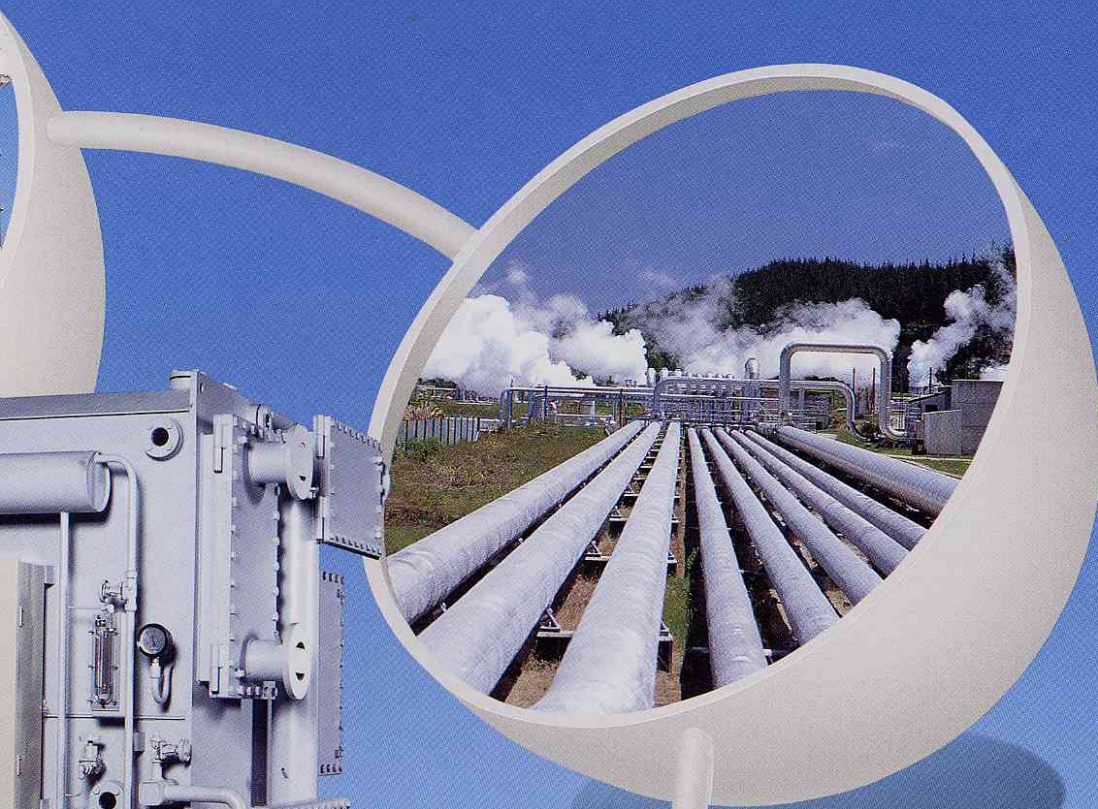

Utilization of heat from hot springs  
or factory exhaust



Utilization of exhaust heat from co-generation systems

The demand for heat rises incessantly. And now the demand is not just for heat but for clean energy that doesn't harm the environment. A vital issue confronting not just industry but all kinds of fields is how to make efficient use of finite energy resources and slow down global warming. The EBARA Model RCH Absorption Chiller driven by low temp. hot water is one of the answers to society's new demands. This machine can use all kinds of heat sources for its refrigeration cycle - including natural energy such as hot spring heat and solar heat, as well as incineration plant exhaust heat, industrial exhaust heat, co-generation system energy, and more. Being able to efficiently utilize such a variety of energy sources means that this machine can make an important contribution to efficient energy use.

# Smaller, Lighter, Energy-Saving Low Temperature Hot Water Refrigerating Machines: The RCH Series Absorption Chillers

## Features

### Energy-Saving

**COP=0.75**  
Under the condition Cold water 13/8°C Cooling water 31/36°C & Hot water 88/83°C

- \* Improved efficiency with high performance heat transfer tubes high efficiency heat exchanger - energy savings of 10% compared to our previous models.
- \* Efficient utilization of engine exhaust heat from co-generation systems (hot water temperature 80 - 90°C). Provide large refrigeration capacity.
- \* High performance absorption can reduce chiller drive hot water pump kW requirement.

### Compact Design

- \* The unique and simple structure, combined with the adoption of a spray type generator, mean that installation area and operating weight are both reduced -in fact, this machine is 40% smaller and lighter than our previous models.

### Purge System

- \* Combination of hermetic purge and palladium cell provides automatic purge, making daily purging operation by the user unnecessary!  
Vacuum pump purging is only recommended every 800 operation hrs.

### High reliability

- \* This machine is specially adapted for hot water from proven steam driven absorption refrigeration machines going back 30 years. The only moving components are the pumps-a high reliability hermetic pump of proven performance.

### Cooling water temperature

- \* No need of temperature control of cooling water even if it falls to 15°C. This improves chiller performance.

### ● Operation Cycle Diagram

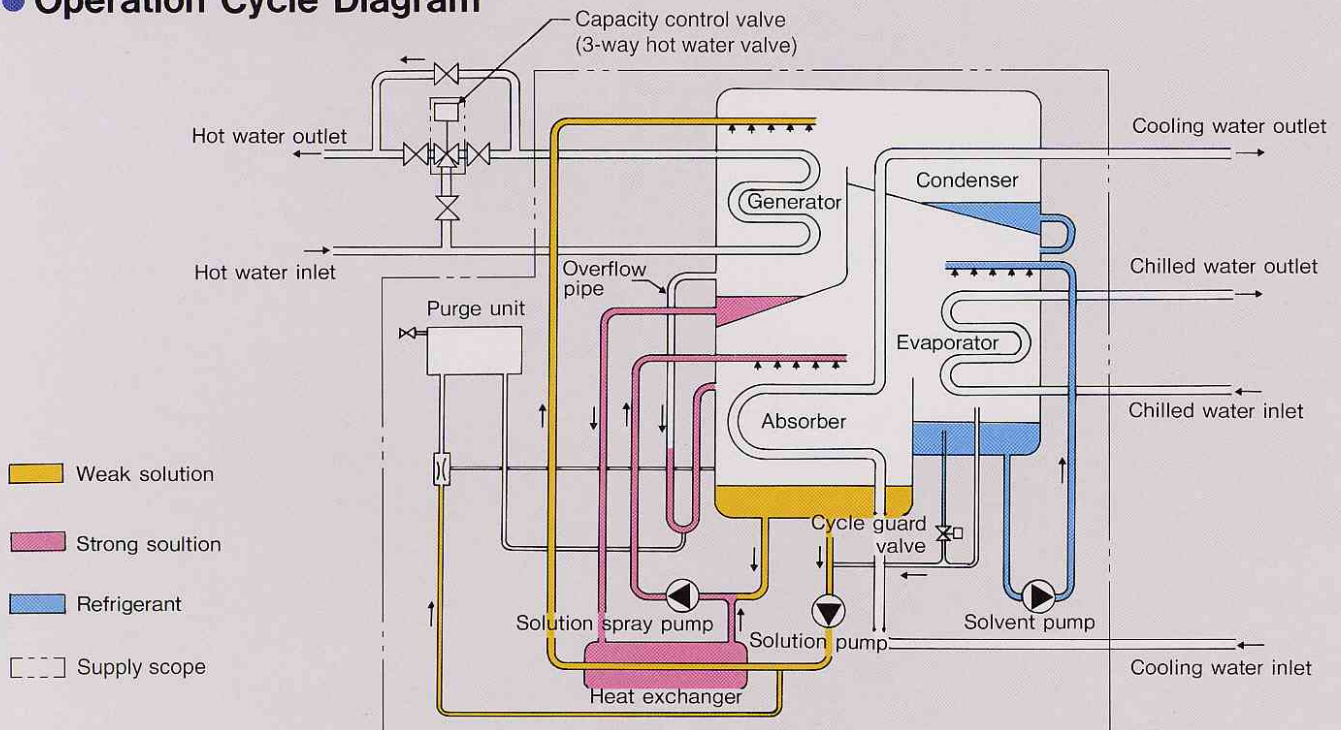

# Specifications

Model		RCH	010	013	016	020	026	032	040	052	064	080
Refrigerating capacity		USRt	45	60	70	90	115	145	180	235	290	360
		{kW}	158	211	246	316	404	510	633	826	1020	1266
Chilled water	Flow rate	m <sup>3</sup> /min	0.45	0.605	0.705	0.910	1.16	1.46	1.81	2.37	2.92	3.63
	Pressure loss	mAq	5.5	6.0	5.5	5.5	5.5	5.5	5.5	5.5	5.5	5.5
		{kPa}	54	59	54	54	54	54	54	54	54	54
Cooling water	Flow rate	m <sup>3</sup> /min	1.07	1.43	1.67	2.14	2.74	3.45	4.28	5.59	6.90	8.57
	Pressure loss	mAq	6.5	7.0	6.5	6.0	6.0	6.0	6.0	6.0	6.0	6.0
		{kPa}	64	69	64	59	59	59	59	59	59	59
Hot water	Flow rate	m <sup>3</sup> /min	0.64	0.85	0.99	1.27	1.63	2.05	2.55	3.32	4.10	5.09
	Pressure loss	mAq	5.0	5.5	5.0	7.5	7.5	7.5	7.5	7.5	7.5	7.5
		{kPa}	49	54	49	74	74	74	74	74	74	74
Electricity	Refrigerant pump	kW	0.15	0.15	0.15	0.3	0.3	0.3	0.4	0.3kWx2	0.3kWx2	0.4kWx2
	Solution pump	kW	0.55	0.55	0.75	0.75	0.75	1.5	1.5	0.75kWx2	1.5kWx2	1.5kWx2
	Spray pump	kW	0.4	0.4	0.4	0.4	0.4	0.4	0.75	0.4kWx2	0.4kWx2	0.75kWx2
	Power supply	kVA	4.9	4.9	5.7	6.1	6.1	7.6	8.5	10.7	13.7	15.5
Dimensions	Length	mm	2000	2035	2100	3540	3540	3630	3630	4030	4055	4055
	Width	mm	1265	1350	1450	1240	1350	1450	1570	2780	2860	3140
	Height	mm	2010	2180	2290	2010	2180	2290	2490	2460	2520	2740
Weight	Operating weight {mass}	t	4.0	4.5	5.1	6.0	7.0	8.6	10.3	14.5	17.7	20.8
	Shipping weight {mass}	t	3.3	3.7	4.0	5.0	5.8	6.6	7.7	5.8	6.6	7.9

## Notes:

- Hot water pressure loss does not include capacity control valve pressure loss.
- Shipping style: RCH010~040 / 1PC  
RCH052~080 / 2PCs
- Fouling factor of chilled, cooling and hot water is 0.0001 m<sup>2</sup> h°C/kcal {0.000086 m<sup>2</sup> K/W}.
- Maximum operating pressure of chilled, cooling and hot water is 8kgf/cm<sup>2</sup>(780KPa).
- Performance is calculated for temperatures of 12-7°C, 31-36°C and 88 - 83°C for chilled, cooling and hot water respectively.
- Power supply is 200V x 50Hz, 200/220V x 60Hz as standard.
- Space required for tube removal is 1500mm in Models RCH-010-016 and 3000mm in Models RCH020-080.

## ● Dimensions (Models RCH010-040)

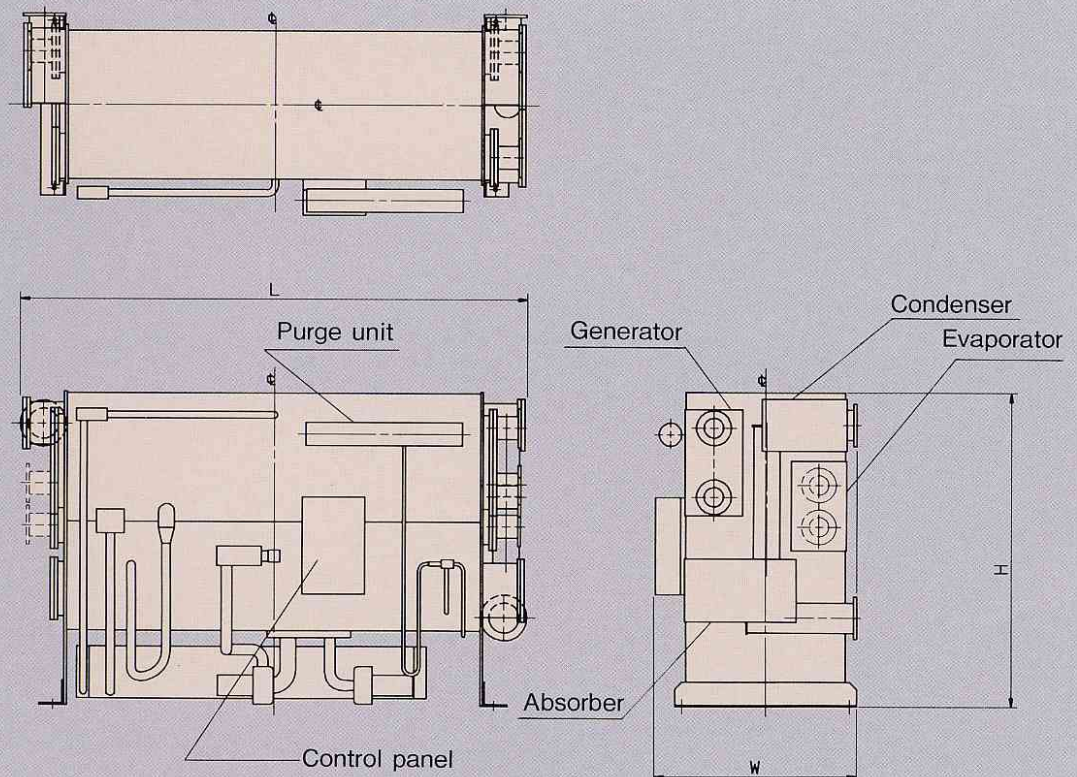

# Applications

## ● Gas Co-generation Systems

Co-generation systems, which derive two or more types of energy - electricity and heat for example - from a single energy source, are high efficiency systems contributing to efficient energy utilization. Their final energy efficiency is as high as 80%, and they are expected to play an important role in reducing CO<sub>2</sub> emission. Effective energy is about 30% electricity and 50% heat. Since the heat is much larger than the electricity, finding a way of utilizing the heat can be the key to the introduction of such a system. Co-generation systems are suitable for factories, hotels, hospitals, sports centers and other buildings that have large heat requirements.

### Gas Co-generation System

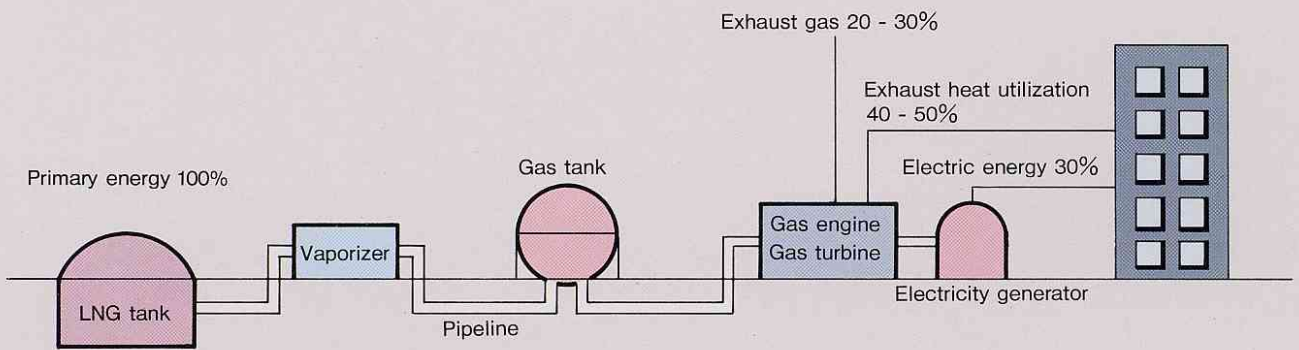

### Example of Gas Engine Co-generation System

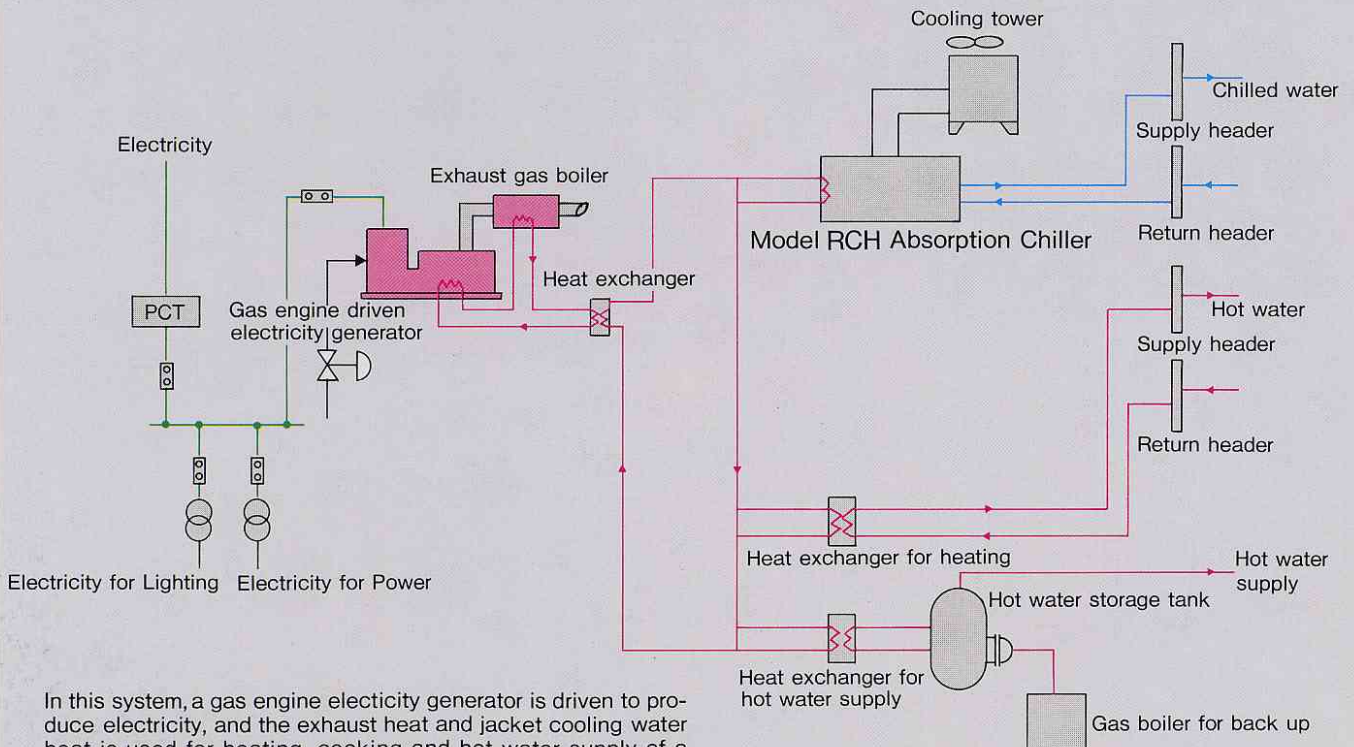

In this system, a gas engine electricity generator is driven to produce electricity, and the exhaust heat and jacket cooling water heat is used for heating, cooking and hot water supply of a building. Incorporating an Absorption Chiller can raise its overall efficiency by as much as 80%. The system can cope principally with electricity generation demand on the scale of 2,000kW, and is suitable for hospitals, hotels, sports centers, etc.

# ● For hot spring and industrial waste water utilization

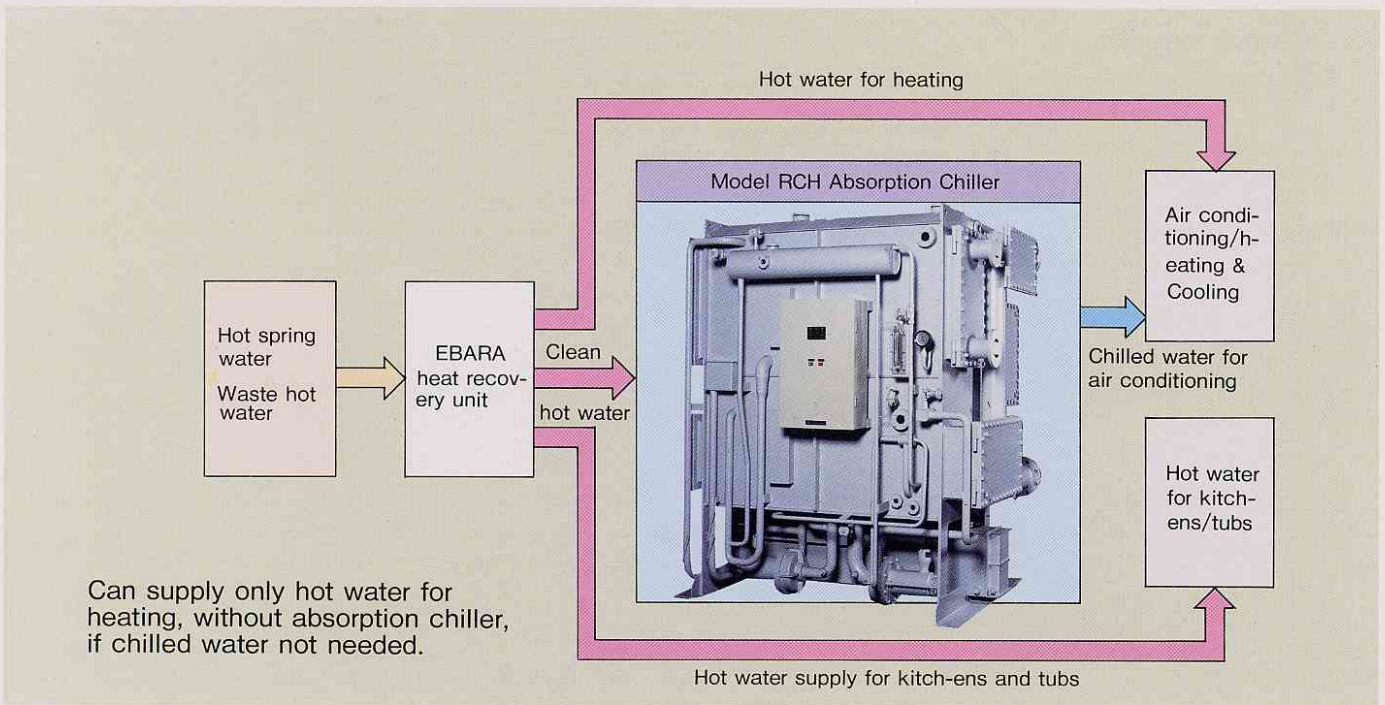

## Introducing a System that Taps Unused Energy-the EBARA Heat Recovery Unit

This unit consists of a heat recovery heat exchanger, a tube automatic cleaning device, an auto strainer, a back washing pump, and a control panel that controls automatic operation. Various equipments are installed above a heat recovery heat exchanger, and the whole is assembled compactly.

The function of this unit is to recover heat from polluted hot water using clean water as an intermediary. Expected applications; as a heat source for refrigerating machines, as a supplier of hot water for buildings or for melting snow, etc.

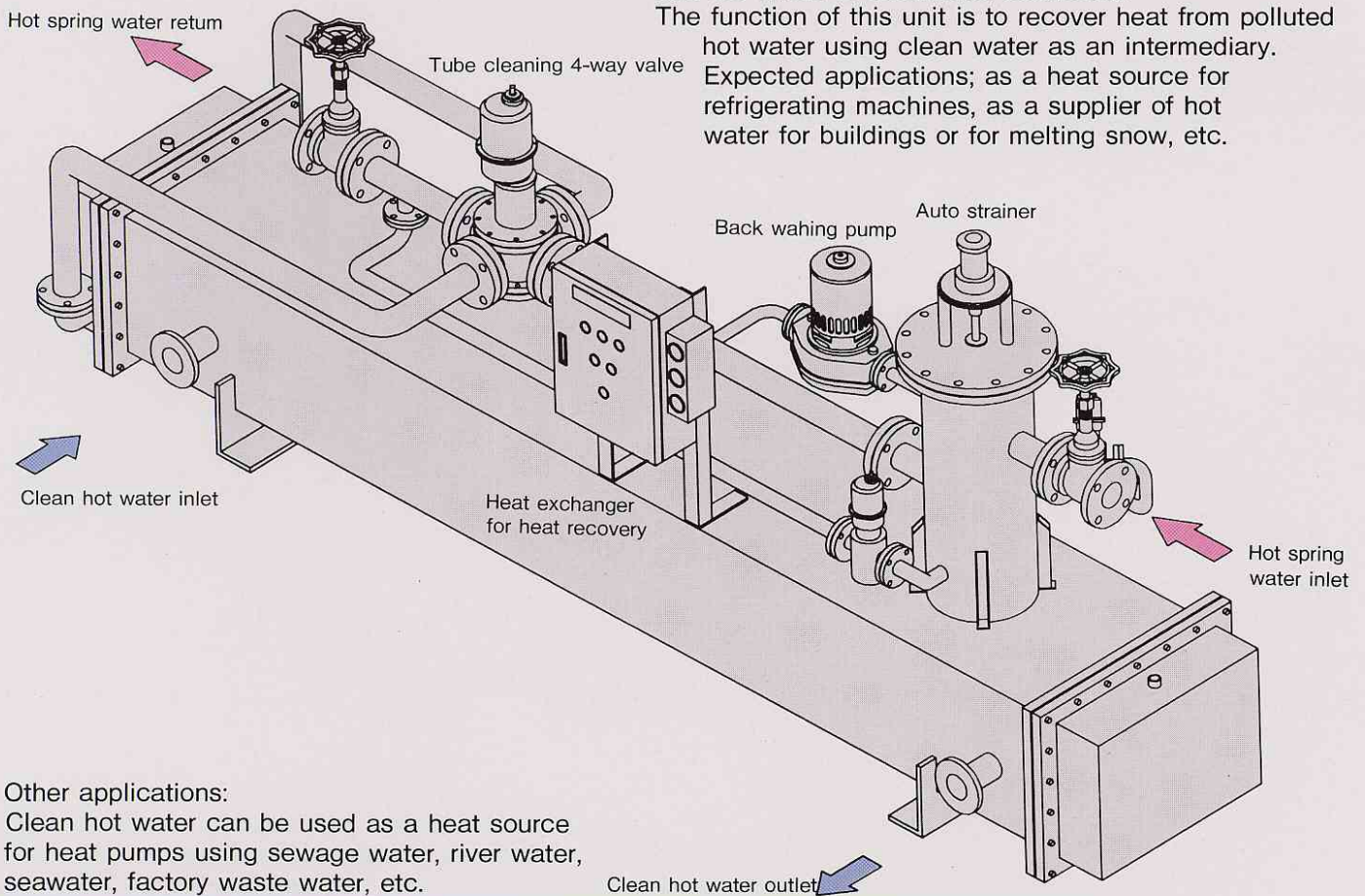

Other applications:  
Clean hot water can be used as a heat source for heat pumps using sewage water, river water, seawater, factory waste water, etc.



# EBARA Refrigeration Equipment & Systems Co., Ltd.

## Head Office & Sales Department

5-1-13 Haneda, Ohta-ku, Tokyo, 144-0043 Japan  
Phone: +81-3-3743-7767 Fax: +81-3-3743-2494

## EBARA CORPORATION

### Head Office:

11-1, Haneda Asahi-cho, Ohta-ku, Tokyo, 144-8510 Japan  
Phone: +81-3-3743-6111 Fax: +81-3-3745-3356

○: Liaison Offices & Distributors

---

### PEOPLE'S REPUBLIC OF CHINA

- Beijing Office  
+86-10-6590-8150~7
- Yantai Ebara Air Conditioning Equipment Co., Ltd.  
+86-535-632-2300

### TAIWAN

- Taipei Office  
+886-2-2567-1310
- Ming Kung Ind. Co., Ltd.  
+886-2-2816-1230

### SINGAPORE

- Ebara Engineering Singapore Pte., Ltd.  
+65-6862-3536

### INDIA

- Kirloskar Pneumatic Co., Ltd.  
+91-(0)-20-26870341

### PAKISTAN

- Arshad Amjad & Abid (Pte) Ltd.  
+92-21-454-2112

### IRAN

- K-O-A Engineers Corporation  
+98-21-888-0292

### ITALY

- Dynamis (Novara)  
+39-32145-7643

### HUNGARY

- Regale KFT  
+36-1-212-2099

### KOREA

- Hanseo Air Conditioning Co., Ltd.  
+82-2-3412-1270~1

### INDONESIA

- P.T. Ebara Indonesia  
+62-21-874-0852

### THAILAND

- Ebara Thailand., Ltd.  
+66-2-216-4935

### MALAYSIA

- Ebara Pumps Malaysia Sdn Bhd  
+60-3-5569-1655

### VIETNAM

- Vietnam Office  
+84-8-406-1602

### EGYPT

- Gascool (The Egyptian Co. For Refrigeration  
by Natural Gas)  
+202-2-270-6390
- Cairo Representative office  
+202-2-736-3466

### TURKEY

- Atlantik Grup  
+90-216-553-9570